

## DS-2CD3756G2T-IZS

### AcuSense 5 MP Varifocal Dome Network Camera



Empowered by deep learning algorithms, Hikvision AcuSense technology brings human and vehicle targets classification alarms to front- and back-end devices. The system focuses on human and vehicle targets, vastly improving alarm efficiency and effectiveness.

- High quality imaging with 5 MP resolution
- Excellent low-light performance with powered-by-DarkFighter technology
- Clear imaging against strong back light due to 120 dB true WDR technology
- Efficient H.265+ compression technology
- Focus on human and vehicle targets classification based on deep learning
- Water and dust resistant (IP67) and vandal-resistant (IK10)
- 3D DNR technology delivers clean and sharp images
- Motorized varifocal lens for easy installation and monitoring



## Specification

Camera	
Image Sensor	1/2.7" Progressive Scan CMOS
Min. Illumination	Color: 0.003 Lux @ (F1.4, AGC ON), B/W: 0 Lux with IR
Shutter Speed	1/3 s to 1/100,000 s
Slow Shutter	Yes
P/N	P/N
Wide Dynamic Range	120 dB
Day & Night	IR cut filter
Power-off Memory	Yes
Angle Adjustment	Pan: 0° to 355°, tilt: 0° to 75°, rotate: 0° to 355°
Lens	
Lens Type	Varifocal lens, motor-driven lens, 2.7 to 13.5 mm and 7 to 35 mm optional
Iris Type	Auto-iris
Lens Mount	2.7 to 13.5 mm: Ø 14 7 to 35 mm: Integrated
Focal Length & FOV	2.7 to 13.5 mm: horizontal FOV 103° to 32°, vertical FOV 73° to 24°, diagonal FOV 142° to 40° 7 to 35 mm: horizontal FOV 28° to 10°, vertical FOV 21° to 8°, diagonal FOV 35° to 13°
Aperture	2.7 to 13.5 mm: F1.4 7 to 35 mm: F1.6
DORI	
DORI	2.7 to 13.5 mm: D: 64 to 187 m, O: 25 to 74 m, R: 12 to 37 m, I: 6 to 18 m 7 to 35 mm: D: 200 to 580 m, O: 79 to 230 m, R: 40 to 116 m, I: 20 to 58 m
Illuminator	
Supplement Light Type	IR
IR Range	2.7 to 13.5 mm: up to 40 m 7 to 35 mm: up to 50 m
IR Wavelength	850 nm
Smart Supplement Light	Yes
Video	
Max. Resolution	2592 × 1944
Main Stream	50 Hz: 25 fps (2592 × 1944, 2688 × 1520, 1920 × 1080, 1280 × 720) 60 Hz: 24 fps (2592 × 1944) 30 fps (2688 × 1520, 1920 × 1080, 1280 × 720)
Sub-Stream	50 Hz: 25 fps (640 × 480, 640 × 360) 60 Hz: 30 fps (640 × 480, 640 × 360)
Third Stream	50 Hz: 10 fps (1920 × 1080, 1280 × 720, 640 × 480, 640 × 360) 60 Hz: 10 fps (1920 × 1080, 1280 × 720, 640 × 480, 640 × 360) *Third stream is supported under certain settings.
Fourth Stream	50 Hz: 10 fps (1280 × 720, 640 × 480, 640 × 360) 60 Hz: 10 fps (1280 × 720, 640 × 480, 640 × 360) *Fourth stream is supported under certain settings.
Video Bit Rate	32 Kbps to 16 Mbps

Video Compression	Main stream: H.265/H.264/H.264+/H.265+ Sub-stream: H.265/H.264/MJPEG Third stream: H.265/H.264 Fourth stream: H.265/H.264/MJPEG *Third stream and fourth stream are supported under certain settings.
H.264 Type	Baseline Profile/Main Profile/High Profile
H.265 Type	Main Profile
H.264+	Main stream supports
H.265+	Main stream supports
Bit Rate Control	CBR/VBR
Scalable Video Coding (SVC)	H.264 and H.265 encoding
Region of Interest (ROI)	5 fixed regions for main stream and sub-stream
<b>Audio</b>	
Environment Noise Filtering	Yes
Audio Sampling Rate	8 kHz/16 kHz/32 kHz/44.1 kHz/48 kHz
Audio Compression	G.711ulaw/G.711alaw/G.722.1/G.726/MP2L2/PCM/MP3/AAC
Audio Bit Rate	64 Kbps (G.711ulaw/G.711alaw)/16 Kbps (G.722.1)/16 Kbps (G.726)/32 to 192 Kbps (MP2L2)/8 to 320 Kbps (MP3)/16 to 64 Kbps (AAC)
<b>Network</b>	
Simultaneous Live View	Up to 6 channels
API	Open Network Video Interface (PROFILE S, PROFILE G, PROFILE T), ISAPI, SDK, ISUP
Protocols	TCP/IP, ICMP, HTTP, HTTPS, FTP, DHCP, DNS, DDNS, RTP, RTSP, NTP, UPnP, SMTP, IGMP, 802.1X, QoS, IPv4, IPv6, UDP, Bonjour, SSL/TLS, PPPoE, ARP, SNMP
User/Host	Up to 32 users. 3 user levels: administrator, operator and user
Security	Password protection, complicated password, HTTPS encryption, IP address filter, Security Audit Log, basic and digest authentication for HTTP/HTTPS, TLS 1.1/1.2, WSSE and digest authentication for Open Network Video Interface
Network Storage	MicroSD/SDHC/SDXC card (256 GB) local storage, and NAS (NFS, SMB/CIFS), auto network replenishment (ANR) Together with high-end Hikvision memory card, memory card encryption and health detection are supported.
Client	iVMS-4200, Hik-Connect, Hik-Central
Web Browser	Plug-in required live view: IE 10+ Plug-in free live view: Chrome 57.0+, Firefox 52.0+ Local service: Chrome 57.0+, Firefox 52.0+
<b>Image</b>	
SNR	≥ 52 dB
Day/Night Switch	Day, Night, Auto, Schedule
Target Cropping	Yes
Image Enhancement	BLC, HLC, 3D DNR
Image Parameters Switch	Yes
Image Settings	Rotate mode, saturation, brightness, contrast, sharpness, gain, white balance adjustable by client software or web browser
<b>Interface</b>	
Alarm	2 inputs, 2 outputs (max. 24 VAC/24 VDC, 1 A)

Audio	1 input (line in), 3.5 mm connector, max. input amplitude: 3.3 vpp, input impedance: 4.7 K $\Omega$ , interface type: non-equilibrium; 1 output (line out), 3.5 mm connector, max. output amplitude: 3.3 vpp, output impedance: 100 $\Omega$ , interface type: non-equilibrium
On-Board Storage	Built-in micro SD/SDHC/SDXC slot, up to 256 GB
Hardware Reset	Yes
Ethernet Interface	1 RJ45 10 M/100 M self-adaptive Ethernet port
Power Output	12 VDC, max. 100 mA
<b>Event</b>	
Basic Event	Motion detection (human and vehicle targets classification), video tampering alarm, exception
Smart Event	Unattended baggage detection, object removal detection, scene change detection, audio exception detection
<b>Deep Learning Function</b>	
Face Capture	Yes
Perimeter Protection	Line crossing detection, intrusion detection, region entrance detection, region exiting detection
<b>General</b>	
Storage Conditions	-30 $^{\circ}$ C to 60 $^{\circ}$ C ( -22 $^{\circ}$ F to 140 $^{\circ}$ F). Humidity 95% or less (non -condensing)
Linkage Method	Upload to NAS/memory card/FTP, notify surveillance center, trigger recording, trigger capture, send email, audible warning
Firmware Version	V5.5.112
Web Client Language	33 languages English, Russian, Estonian, Bulgarian, Hungarian, Greek, German, Italian, Czech, Slovak, French, Polish, Dutch, Portuguese, Spanish, Romanian, Danish, Swedish, Norwegian, Finnish, Croatian, Slovenian, Serbian, Turkish, Korean, Traditional Chinese, Thai, Vietnamese, Japanese, Latvian, Lithuanian, Portuguese (Brazil), Ukrainian
General Function	Anti-flicker, heartbeat, mirror, privacy mask, flash log, password reset via email, pixel counter
Software Reset	Yes
Startup and Operating Conditions	-30 $^{\circ}$ C to 60 $^{\circ}$ C ( -22 $^{\circ}$ F to 140 $^{\circ}$ F). Humidity 95% or less (non -condensing)
Power Supply	12 VDC $\pm$ 25% PoE: 802.3af, class 3
Power Consumption and Current	12 VDC, 0.9 A, max. 10.8 W PoE (802.3af, 36 V to 57 V), 0.36 A to 0.23 A, max. 12.9 W
Power Interface	$\varnothing$ 5.5 mm coaxial power plug
Camera Material	Metal
Camera Dimension	$\varnothing$ 153.3 mm $\times$ 111.6 mm (6.0" $\times$ 4.4")
Package Dimension	261 mm $\times$ 217 mm $\times$ 197 mm (10.3" $\times$ 8.5" $\times$ 7.8")
Camera Weight	Approx. 885 g (1.9 lb.)
With Package Weight	Approx. 1843 g (3.2 lb.)

## Approval

EMC	FCC SDoC (47 CFR Part 15, Subpart B); CE-EMC (EN 55032: 2015, EN 61000-3-2: 2014, EN 61000-3-3: 2013, EN 50130-4: 2011 +A1: 2014); RCM (AS/NZS CISPR 32: 2015); IC VoC (ICES-003: Issue 6, 2016); KC (KN 32: 2015, KN 35: 2015)
Safety	UL (UL 60950-1); CB (IEC 60950-1:2005 + Am 1:2009 + Am 2:2013, IEC 62368-1:2014); CE-LVD (EN 60950-1:2005 + Am 1:2009 + Am 2:2013, IEC 62368-1:2014); BIS (IS 13252(Part 1):2010+A1:2013+A2:2015); LOA (IEC/EN 60950-1)
Environment	CE-RoHS (2011/65/EU); WEEE (2012/19/EU); Reach (Regulation (EC) No 1907/2006)
Protection	IP67 (IEC 60529-2013), IK10 (IEC 62262:2002)

## Available Model

DS-2CD3756G2T-IZS (2.7 to 13.5 mm, 7 to 35 mm)

## Dimension

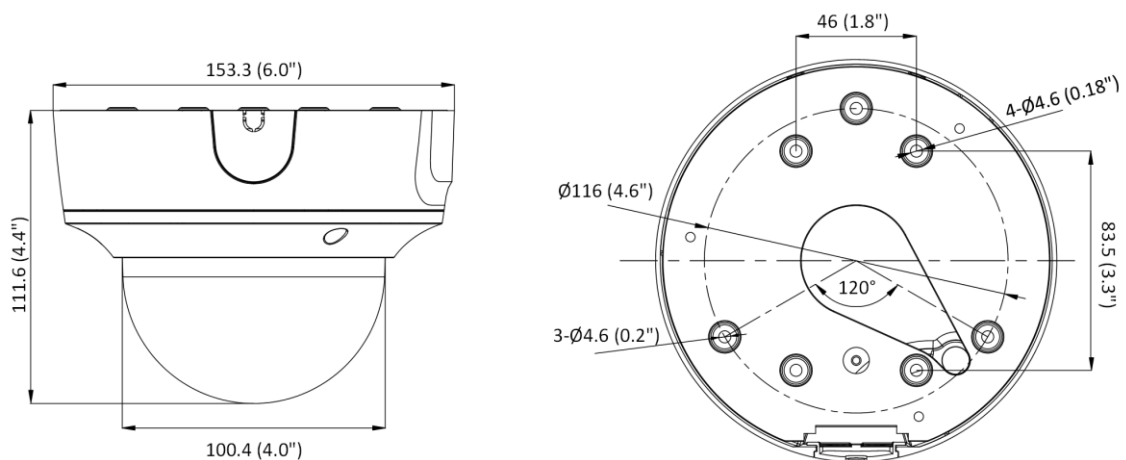

Unit: mm (inch)





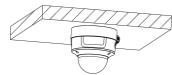

**Accessory  
Included**

**DS-1280ZJ-DM55**

**Junction box**

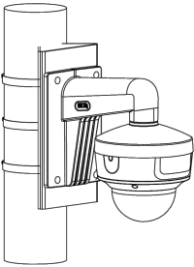
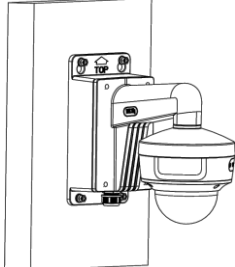
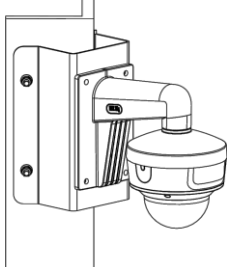
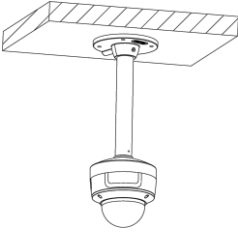
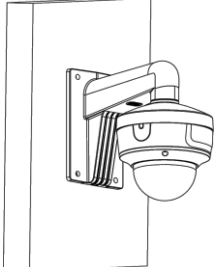

**Optional**

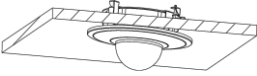
<p><b>DS-1475ZJ-SUS</b> Vertical Pole Mount</p>	<p><b>DS-1473ZJ-155B</b> Wall Mount</p>	<p><b>DS-1476ZJ-SUS</b> Corner Mount</p>	<p><b>DS-1471ZJ-155</b> Pendant Mount</p>	<p><b>DS-1473ZJ-155</b> Wall Mount</p>
				
				
<p><b>DS-1227ZJ-DM44</b> <b>Pendant Mount</b></p>  				

Distributed by

**Authorised Reseller in Cambodia.  
Powercom Group Co., Ltd.**

No.10, Street 420, Sangkat Boeung Trabek,  
Khan Chamkarmorn, Phnom Penh, Cambodia.  
Tel: (+855)23 990 630; Fax: (+855)23 990 631  
Email: [info@powercom-group.com](mailto:info@powercom-group.com)  
<https://www.powercom-group.com>

**HIKVISION®****Headquarters**

No.555 Qianmo Road, Binjiang District,  
Hangzhou 310051, China  
T +86-571-8807-5998  
[overseasbusiness@hikvision.com](mailto:overseasbusiness@hikvision.com)

**Hikvision USA**  
T +1-909-895-0400  
[sales.usa@hikvision.com](mailto:sales.usa@hikvision.com)

**Hikvision Australia**  
T +61-2-8599-4233  
[salesau@hikvision.com](mailto:salesau@hikvision.com)

**Hikvision India**  
T +91-22-28469900  
[sales@pramahikvision.com](mailto:sales@pramahikvision.com)

**Hikvision Canada**  
T +1-866-200-6690  
[sales.canada@hikvision.com](mailto:sales.canada@hikvision.com)

**Hikvision Thailand**  
T +662-275-9949  
[sales.thailand@hikvision.com](mailto:sales.thailand@hikvision.com)

**Hikvision Europe**  
T +31-23-5542770  
[sales.eu@hikvision.com](mailto:sales.eu@hikvision.com)

**Hikvision Italy**  
T +39-0438-6902  
[info.it@hikvision.com](mailto:info.it@hikvision.com)

**Hikvision Brazil**  
T +55 11 3318-0050  
[Latam.support@hikvision.com](mailto:Latam.support@hikvision.com)

**Hikvision Turkey**  
T +90 (216)521 7070- 7074  
[sales.tr@hikvision.com](mailto:sales.tr@hikvision.com)

**Hikvision Malaysia**  
T +601-7652-2413  
[sales.my@hikvision.com](mailto:sales.my@hikvision.com)

**Hikvision UK & Ireland**  
T +01628-902140  
[sales.uk@hikvision.com](mailto:sales.uk@hikvision.com)

**Hikvision South Africa**  
Tel: +27 (10) 0351172  
[sale.africa@hikvision.com](mailto:sale.africa@hikvision.com)

**Hikvision France**  
T +33(0)1-85-330-450  
[info.fr@hikvision.com](mailto:info.fr@hikvision.com)

**Hikvision Kazakhstan**  
T +7-727-9730667  
[nikia.panfilov@hikvision.ru](mailto:nikia.panfilov@hikvision.ru)

**Hikvision Vietnam**  
T +84-974270888  
[sales.vt@hikvision.com](mailto:sales.vt@hikvision.com)

**Hikvision UAE**  
T +971-4-4432090  
[salesme@hikvision.com](mailto:salesme@hikvision.com)

**Hikvision Singapore**  
T +65-6684-4718  
[sg@hikvision.com](mailto:sg@hikvision.com)

**Hikvision Spain**  
T +34-91-737-16-55  
[info.es@hikvision.com](mailto:info.es@hikvision.com)

**Hikvision Tashkent**  
T +99-87-1238-9438  
[uzb@hikvision.ru](mailto:uzb@hikvision.ru)

**Hikvision Hong Kong**  
T +852-2151-1761  
[info.hk@hikvision.com](mailto:info.hk@hikvision.com)

**Hikvision Russia**  
T +7-495-669-67-99  
[saleru@hikvision.com](mailto:saleru@hikvision.com)

**Hikvision Korea**  
T +82-(0)31-731-8817  
[sales.korea@hikvision.com](mailto:sales.korea@hikvision.com)

**Hikvision Poland**  
T +48-22-460-01-50  
[info.pl@hikvision.com](mailto:info.pl@hikvision.com)

**Hikvision Indonesia**  
T +62-21-2933759  
[Sales.Indonesia@hikvision.com](mailto:Sales.Indonesia@hikvision.com)

**Hikvision Colombia**  
[sales.colombia@hikvision.com](mailto:sales.colombia@hikvision.com)