

**APC**<sup>™</sup>

by Schneider Electric

# Installation and Operation Smart-UPS<sup>™</sup> Uninterruptible Power Supply

SURTD3000XLI  
SURTD5000XLI

220/230/240 Vac

Tower/Rack-Mount 3U

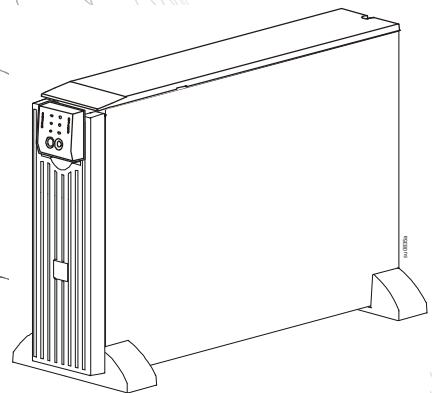

# **Smart-UPS™ RT**

**Uninterruptible Power Supply**

**SURTD 3000/5000 VA 200-240 Vac**

**Tower/Rack-Mount 3U**

**English**

# **INTRODUCTION**

The APC™ by Schneider Electric Smart-UPS™ RT is a high performance, uninterruptible power supply (UPS). The UPS provides protection for electronic equipment from utility power blackouts, brownouts, sags, and surges and small utility fluctuations and large disturbances. The UPS also provides battery backup power for connected equipment until utility power returns to safe levels or the batteries are fully discharged.

This user manual is available on the enclosed Documentation CD and on the APC by Schneider Electric web site, [www.apc.com](http://www.apc.com).

# **INSTALLATION**

**Read the Safety Guide before installing the UPS.**

## ***Unpacking***

Inspect the UPS upon receipt. Notify the carrier and dealer if there is damage.

The packaging is recyclable; save it for reuse or dispose of it properly.

Check the package contents:

- UPS (with battery modules disconnected)
- Front bezel
- Literature kit containing:
  - Product documentation
  - Smart-UPS RT User Manuals CD
  - Warranty Information
- *XLT/XLI/XLTW models:* PowerChute™ software CD
- Serial cable
- *3000 VA XLI models:* two output power cords, two input power cords
- *3000 VA models:* conversion faceplate for accommodating a Network Management Card
- *5000 VA XLI models:* four output power cords, Network Management Card documentation

## ***Specifications***

<b>TEMPERATURE</b> OPERATING STORAGE	32° to 104° F (0° to 40° C) 5° to 113° F (-15° to 45° C) charge the UPS battery every six months	This unit is intended for indoor use only. Select a location sturdy enough to handle the weight.  Do not operate the UPS where there is excessive dust or the temperature and humidity are outside the specified limits.  <b>Ensure that the air vents on the front and rear of the UPS are not blocked.</b>
<b>MAXIMUM ELEVATION</b> OPERATING STORAGE	10,000 ft (3,000 m) 50,000 ft (15,240 m)	
<b>HUMIDITY</b>	0 to 95% relative humidity	
<b>WEIGHT</b>	UPS 120 lbs (55 kg) UPS with packaging 140 lbs (64 kg)	

## Wiring and Connecting the UPS

### 5000 VA XLI MODELS ONLY: HARDWIRING INSTRUCTIONS

- Wiring must be performed by a qualified electrician.
- Install a high magnetic 30/32 A utility circuit breaker.
- Adhere to all national and local electrical codes.
- Use #10 AWG gauge (5 mm<sup>2</sup>) wire.

1. Switch the utility circuit breaker OFF.
2. Remove the input access panel.
3. Remove circular knockout.

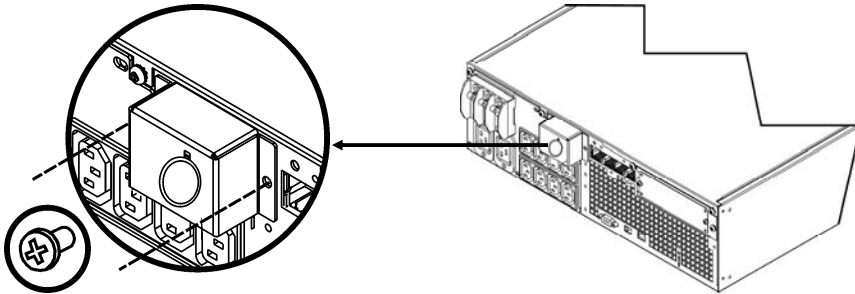

4. Run #10 AWG gauge (5 mm<sup>2</sup>) wire through the access panel, and connect the wires to the terminal block (Green: Ground, Brown: Hot, Blue: Neutral). Use an appropriate strain relief (not included).

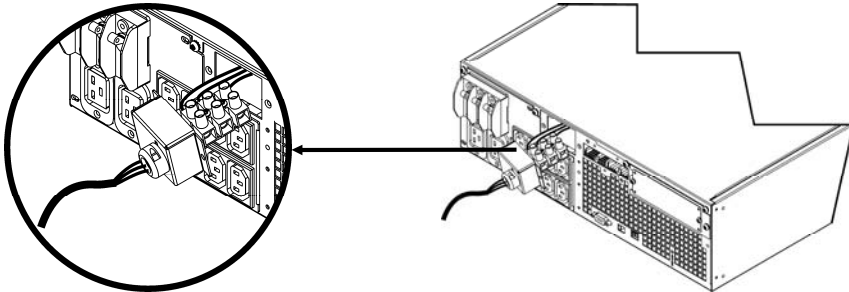

5. Switch the utility circuit breaker ON.
6. Check line voltages.
7. Replace the access panel.

**CONNECTING THE BATTERY MODULES AND ATTACHING THE FRONT BEZEL**

∂

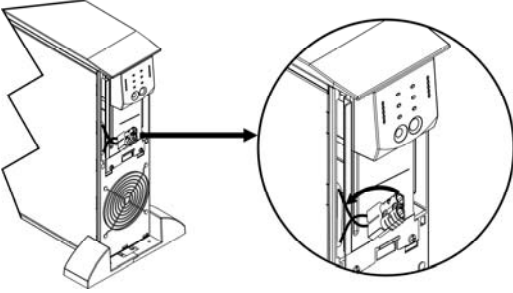

•

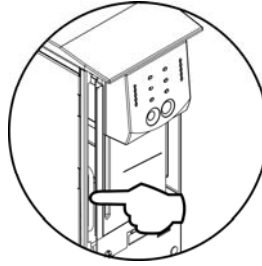

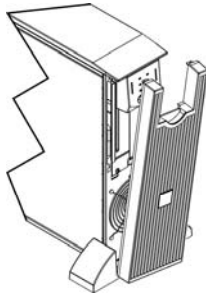

+

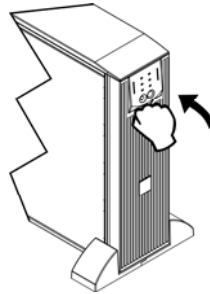

≠

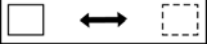

**BASIC CONNECTORS**

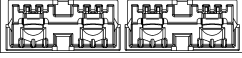
 <p><b>serial com</b></p>	<p>The serial connector is to be used for interfacing with APC by Schneider Electric PowerChute software and terminal emulation software.</p> <p><b>Use only APC by Schneider Electric approved cables.</b></p> <p><b>Any other interface cable will be incompatible with the UPS connector.</b></p>
 <p><b>normal bypass</b></p>	<p>Manual bypass enables the user to manually put connected equipment into bypass mode.</p>
 <p><b>EPO terminal</b></p>	<p>Emergency Power Off terminal allows the user to connect the UPS to the central EPO system.</p>
 <p><b>TVSS screw</b></p>	<p>The UPS features a transient voltage surge suppression (TVSS) screw for connecting the ground lead on surge suppression devices such as telephone and network line protectors.</p> <p><b>When connecting grounding cable, disconnect the unit from the utility power outlet.</b></p>
 <p><b>external battery pack connector</b></p>	<p>Optional external battery packs provide extended run time during power outages. These units support up to ten external battery packs.</p> <p>See the APC by Schneider Electric web site, <a href="http://www.apc.com">www.apc.com</a> for the information on the external battery pack, SURT192XLBP.</p>

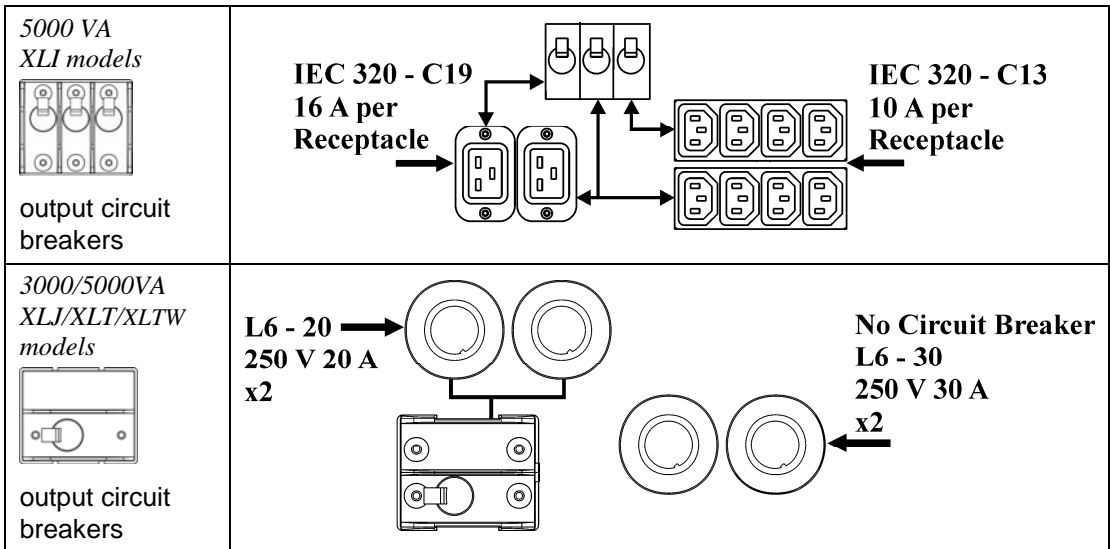

## **CONNECTING EQUIPMENT AND POWER TO THE UPS**

1. Connect equipment to the UPS (cables not included for XLJ/XLT/XLTW models).
2. **Avoid using extension cords.**
  - *3000 VA XLJ/XLT/XLI/XLTW and 5000 VA XLJ/XLT/XLTW models:* Using a power cord, plug the UPS into a two-pole, three-wire, grounded receptacle only.
  - *5000 VA XLJ models:* To draw full 5000 VA from the UPS have a qualified electrician cut off the input plug and hardwire the UPS to the appropriate power panel.
3. Turn on all connected equipment. To use the UPS as a master ON/OFF switch, ensure all connected equipment is switched ON. The equipment will not be powered until the UPS is turned on.
4. To power up the UPS press the  button on the front panel.
  - The UPS battery charges when it is connected to utility power. The battery charges to 90% capacity during the first three hours of normal operation. **Do not** expect full battery run capability during this initial charge period.
5. For additional computer system security, install PowerChute *Server* Smart-UPS monitoring software.

## **OPTIONS**

Refer to the APC by Schneider Electric web site, [www.apc.com](http://www.apc.com) for available accessories.

- External Battery Pack SURT192XLBP
- Rail Kit SURTRK2
- Isolation Transformer
- Service Bypass Panel

# OPERATION

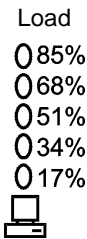

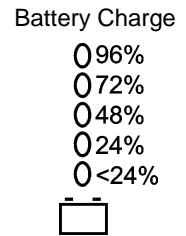
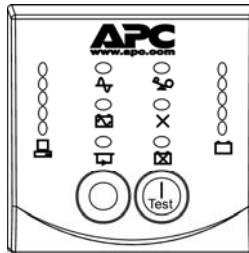

## SMART-UPS RT FRONT DISPLAY







<b>Indicator</b>	<b>Description</b>
Online 	The Online LED illuminates when the UPS is drawing utility power and performing double conversion to supply power to connected equipment.
On Battery 	The UPS is supplying battery power to the connected equipment.
Bypass 	The Bypass LED illuminates indicating that the UPS is in bypass mode. Utility power is sent directly to connected equipment during bypass mode operation. Bypass mode operation is the result of an internal UPS fault, an overload condition or a user initiated command either through an accessory or the manual bypass switch. Battery operation is not available while the UPS is in bypass mode. Refer to <i>Troubleshooting</i> in this manual.
Fault 	The UPS detects an internal fault. Refer to <i>Troubleshooting</i> in this manual.
Overload 	An overload condition exists. See <i>Troubleshooting</i> .
Replace Battery 	The battery is disconnected or must be replaced. See <i>Troubleshooting</i> .

<b>Feature</b>	<b>Function</b>
Power On 	Press this button to turn on the UPS. (See below for additional capabilities.)
Power Off 	Press this button to turn off the UPS.



<b>Feature</b>	<b>Function</b>
Cold Start 	When there is no utility power and the UPS is off, press and hold the  button to power up the UPS and connected equipment.  The UPS will emit two beeps. During the second beep, release the button.
Self-Test	<p><b>Automatic:</b> The UPS performs a self-test automatically when turned on, and every two weeks thereafter (by default). During the self-test, the UPS briefly operates the connected equipment on battery.</p> <p><b>Manual:</b> Press and hold the  button for a few seconds to initiate the self-test.</p>

Diagnostic Utility Voltage <b>200V 208V</b> 0 236 0 245 0 217 0 226 0 199 0 207 0 180 0 189 0 161 0 170  <b>220V 230V 240V</b> 0 256 0 266 0 276 0 238 0 248 0 258 0 219 0 229 0 239 0 200 0 210 0 220 0 181 0 192 0 202 	<p>The UPS has a diagnostic feature that displays the utility voltage. Plug the UPS into the normal utility power.</p> <p><b>The UPS starts a self-test as part of this procedure. The self-test does not affect the voltage display.</b></p> <p>Press and hold the  button to view the utility voltage bar graph display. The five-LED, <i>Battery Charge</i>  display on the right of the front panel shows the utility input voltage.</p> <p>Refer to the figure at left for the voltage reading (values are not listed on the UPS).</p> <p>The display indicates the voltage is between the displayed value on the list and the next higher value.</p>
--	--

## USER CONFIGURABLE ITEMS

NOTE: SETTINGS ARE MADE THROUGH SUPPLIED POWERCHUTE SOFTWARE, OPTIONAL SMART SLOT ACCESSORY CARDS, OR TERMINAL MODE.			
FUNCTION	FACTORY DEFAULT	USER SELECTABLE CHOICES	DESCRIPTION
Automatic Self-Test	On start-up and every 14 days, thereafter	On start-up and every 7 days thereafter On start-up and every 14 days thereafter On start-up only No self-test	Set the interval at which the UPS will execute a self-test.
Date of Last Battery Replacement	Manufacture date	Date of battery replacement	Reset this date when you replace the battery modules.
Minimum Run time Before Return from Shutdown	0 seconds	0 to 3600 s of run time	Specify the minimum run time following a low battery shutdown, before powering connected equipment.
Audible Alarm Setting	ON	ON, OFF	Enable or disable all alarms permanently.
Simple Shutdown Delay	90 seconds	0 to 1800 s	Set the interval between the time when the UPS receives a simple shutdown command and the actual shutdown.
Simple Low Run Time Warning	150 seconds	0 to 1800 s	Change the warning interval default to a higher setting if the operating system requires a longer interval for shutdown.  The low battery warning beeps are continuous when 150 seconds of run time remain.
High Bypass Point	255 VAC	<i>Output Voltage Setting</i> 200 VAC: 210 - 280 VAC 208 VAC: 220 - 280 VAC 220 VAC: 235 - 280 VAC 230 VAC: 245 - 280 VAC 240 VAC: 255 - 280 VAC	Maximum voltage that the UPS will pass to connected equipment during internal bypass operation.

NOTE: SETTINGS ARE MADE THROUGH SUPPLIED POWERCHUTE SOFTWARE, OPTIONAL SMART SLOT ACCESSORY CARDS, OR TERMINAL MODE.

FUNCTION	FACTORY DEFAULT	USER SELECTABLE CHOICES	DESCRIPTION
Low Bypass Point	160 VAC	<i>Output Voltage Setting</i> 200 VAC: 160 - 185 VAC 208 VAC: 160 - 190 VAC 220 VAC: 160 - 195 VAC 230 VAC: 160 - 200 VAC 240 VAC: 160 - 205 VAC	Minimum voltage that the UPS will pass to connected equipment during internal bypass operation.
Output Voltage	<i>XLJ models:</i> 200 VAC <i>XLT models:</i> 208 VAC <i>XLTW models:</i> 220 VAC <i>XLI models:</i> 230 VAC	200, 208, 220, 230, 240 VAC	Allows the user to select the on-line output voltage.
Output Frequency	Automatic 50 ± 3 Hz or 60 ± 3 Hz	50 ± 3 Hz    60 ± 3 Hz 50 ± 1 Hz    60 ± 1 Hz 50 ± 0.1 Hz    60 ± 0.1 Hz 50 ± 3 Hz or 60 ± 3 Hz	Sets the allowable UPS output frequency. Whenever possible, the output frequency tracks the input frequency.
Number of External Battery Packs	0	0 to 100	Defines the number of external connected battery packs for proper run time prediction.
Bypass Acceptable	Not required	Required/ Not required	Phase and frequency lock required/not required before the UPS will switch to bypass.

## **CONNECTING THE EPO (EMERGENCY POWER OFF) OPTION**

The output power can be disabled in an emergency by closing a switch connected to the EPO.

**Adhere to National and local electrical codes when wiring the EPO.**

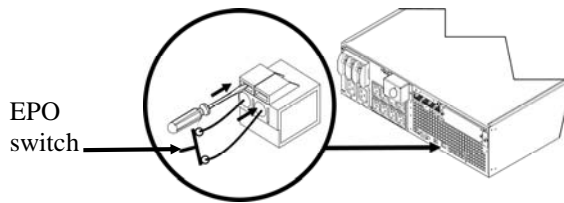

The EPO switch is internally powered by the UPS for use with non-powered switch circuit breakers.

The EPO circuit is considered a Class 2 circuit, (UL, CSA standards) and a SELV circuit (IEC standard).

Both Class 2 and SELV circuits must be isolated from all primary circuitry. Do not connect any circuit to the EPO terminal block unless it can be confirmed that the circuit is Class 2 or SELV.

If circuit standard cannot be confirmed, use a contact closure switch.

Use one of the following cable types to connect the UPS to the EPO switch:

- CL2: Class 2 cable for general use
- CL2P: Plenum cable for use in ducts, plenums, and other spaces used for environmental air.
- CL2R: Riser cable for use in a vertical run in a floor to floor shaft.
- CLEX: Limited use cable for use in dwellings and for use in raceways.
- For installation in Canada: Use only CSA certified, type ELC (extra-low voltage control cable).

## **TERMINAL MODE TO CONFIGURE UPS PARAMETERS**

3000 VA models:

Terminal Mode is a menu driven interface that enables configuration of the UPS by users not wishing to use PowerChute software or an optional Network Management Card.

Connect the serial cable to the serial com connector on the back of the UPS.

If PowerChute software is not installed do not perform steps 1 and 7.

1. For Windows users: STOP the PowerChute *Server* using the following steps:
  - From the Desktop, go to **Start => Settings => Control Panel => Administrative Tools => Services.**
  - Select **APC PowerChute Server** – right click the mouse and select **Stop.**
- 1a. For Linux users: STOP the PowerChute *Server* using the following steps:
  - Change directory to **/etc/init.d.**
  - Initiate the command **./PowerChute stop.**
2. Open a terminal program. Example: HyperTerminal
  - From the Desktop, go to **Start => Programs => Accessories => Communication =>HyperTerminal.**
3. Double-click on the **HyperTerminal** icon.
  - Follow the prompts to choose a name and select an icon. Disregard the message, “...must install a modem,” if it is displayed. Click OK.
  - Select the **COM** port that is connected to your UPS. The port settings are:
    - ✓ ***bits per second - 9600***
    - ✓ ***data - bits 8***
    - ✓ ***parity - none***
    - ✓ ***stop bit - 1***
    - ✓ ***flow control - none***
  - Press ENTER
4. Press 1 to modify the UPS parameters.
5. Follow the prompts.
6. Exit the terminal program.
7. For Windows users: START the PowerChute *Server* using the following steps:
  - From the Desktop, go to **Start => Settings => Control Panel => Administrative Tools => Services.**
  - Select **APC PowerChute Server** – right click the mouse and select **Start.**
- 7a. For Linux users: START the PowerChute *Server* using the following steps:
  - Change directory to **/etc/init.d.**
  - Initiate the command **./PowerChute start.**

5000 VA models:

Terminal Mode is a menu driven interface that enables configuration of the UPS by users not using PowerChute software or the installed Network Management Card interfaces.

Connect the serial cable to the serial port on the back of the UPS.

If PowerChute software is not installed do not perform steps 1 and 5.

1. For Windows users: STOP the PowerChute *Server* using the following steps:
  - From the Desktop, go to **Start => Settings => Control Panel => Administrative Tools => Services.**
  - Select **APC PowerChute Server** – right click the mouse and select **Stop.**
- 1a. For Linux users: STOP the PowerChute *Server* using the following steps:
  - Change directory to **/etc/init.d.**
  - Initiate the command **./PowerChute stop.**
2. Open a terminal program. Example: HyperTerminal
  - From the Desktop, go to **Start => Programs => Accessories => Communication =>HyperTerminal.**
3. Double-click on the **HyperTerminal** icon.
  - Follow the prompts to choose a name and select an icon. Disregard the message, “...must install a modem,” if it is displayed. Click OK.
  - Select the **COM** port that is connected to your UPS. The port settings are:
    - ✓ ***bits per second - 9600***
    - ✓ ***data - bits 8***
    - ✓ ***parity - none***
    - ✓ ***stop bit - 1***
    - ✓ ***flow control - none***
  - Press ENTER
4. Example for setting the number of external battery packs (SURT192XLBP):

Once the blank terminal window is open, follow these steps to enter the number of battery packs:

  - Press ENTER to initiate terminal mode. Press ENTER multiple times, until the prompt **User Name:** is displayed. Follow the prompts. Type slowly, waiting until each character appears on the screen prior to typing the next character.

Network Management Card defaults:

  - User Name: apc
  - Password: apc
  - Press 1 and ENTER to select Device Manager.
    - Select the model by entering the corresponding number, then press ENTER.
  - Press 3 and ENTER to select Configuration.
  - Press 1 and ENTER to select Battery.

- Press 2 and ENTER to change the Battery Settings.
    - Type in the number of external battery packs (four battery modules per pack), and press ENTER.  
(Number of packs: 1 = 1 SURT192XLBP, 2 = 2 SURT192XLBP etc.)
  - Press 3 and ENTER to accept the changes.
  - Press ESC multiple times (5) to return to the main menu.
  - Press 4 and ENTER to log out.
5. For Windows users: START the PowerChute *Server* using the following steps:
- From the Desktop, go to **Start => Settings => Control Panel => Administrative Tools => Services.**
  - Select APC by Schneider Electric **PowerChute Server** – right click the mouse and select **Start.**
- 5a. For Linux users: START the PowerChute *Server* using the following steps:
- Change directory to **/etc/init.d.**
  - Initiate the command **./PowerChute start.**

## MAINTENANCE AND TRANSPORT

### **Replacing the Battery Module**

This UPS has an easy to replace, hot-swappable battery module. Replacement is a safe procedure, isolated from electrical hazards. You may leave the UPS and connected equipment on during the procedure. See your dealer or go to the APC by Schneider Electric web site, [www.apc.com](http://www.apc.com) for information on replacement battery modules.

The battery replacement procedure must include replacing all battery modules in the UPS and connected external battery pack(s).



**Once the battery(s) are disconnected, the connected equipment is not protected from power outages.**

**Be careful during battery replacement, the battery modules are heavy.**



**Be sure to deliver spent batteries to a recycling facility or ship to the manufacturer in the replacement battery packing material.**

#### **REMOVING BATTERY MODULES**

1

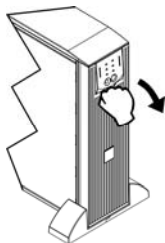

2

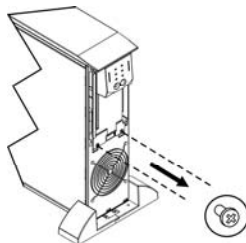

3

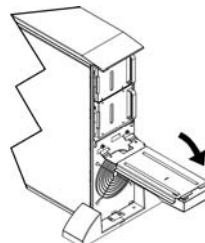
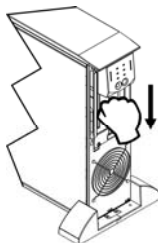

4

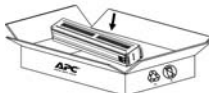
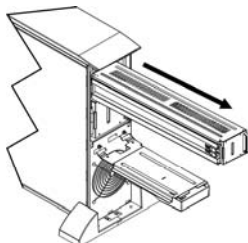

5

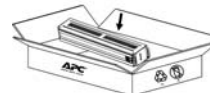
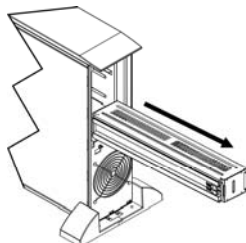



## REPLACING BATTERY MODULES

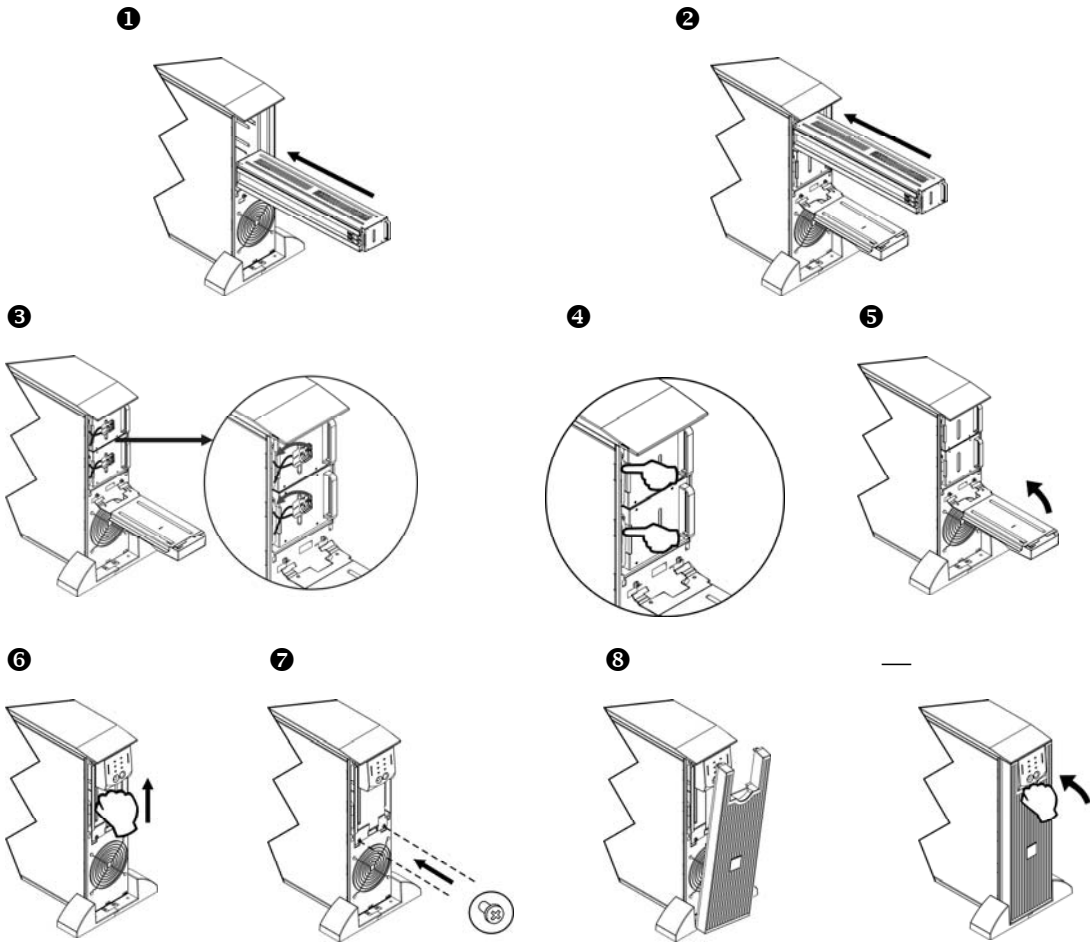

## Disconnecting the Battery for Transport

Always **DISCONNECT THE BATTERY(s)** before shipping in compliance with U.S. Department of Transportation (DOT) and IATA regulations.





The battery(s) may remain in the UPS.

1. Shut down and disconnect any equipment attached to the UPS.
2. Shut down and disconnect the UPS from the power supply.
3. Unplug the battery connectors. Refer to *Replacing Battery modules* in this manual.

For shipping instructions go to the APC by Schneider Electric web site, [www.apc.com](http://www.apc.com).

## **TROUBLESHOOTING, SERVICE, AND WARRANTY INFORMATION**

Use the table below to solve minor installation and operation problems. Refer to the APC by Schneider Electric web site, [www.apc.com](http://www.apc.com) for assistance with complex UPS problems.

<b>PROBLEM AND POSSIBLE CAUSE</b>	<b>SOLUTION</b>
<b>UPS WILL NOT TURN ON</b>	
Battery not connected properly.  button not pushed. UPS not connected to utility power supply. Very low or no utility voltage.	Check that the battery connectors are fully engaged.  Press the  button once to power the UPS and the connected equipment.  Check that the power cable from the UPS to the utility power supply is securely connected at both ends.  Check the utility power supply to the UPS by plugging in a table lamp. If the light is very dim, have the utility voltage checked.
<b>UPS WILL NOT TURN OFF</b>	
 button not pushed. Internal UPS fault.	Press the  button once to turn the UPS off.  Do not attempt to use the UPS. Unplug the UPS and have it serviced immediately.
<b>UPS BEEPS OCCASIONALLY</b>	
Normal UPS operation when running on battery.	None. The UPS is protecting the connected equipment.
<b>UPS DOES NOT PROVIDE EXPECTED BACKUP TIME</b>	
The UPS battery(s) are weak due to a recent outage or battery(s) are near the end of their service life.	Charge the battery(s). Battery modules require recharging after extended outages. They wear faster when put into service often or when operated at elevated temperatures. If the battery(s) are near the end of their service life, consider replacing the battery(s) even if the <i>Replace Battery</i> LED is not illuminated.
<b>FRONT PANEL LEDs FLASH SEQUENTIALLY</b>	
The UPS has been shut down remotely through software or an optional accessory card.	None. The UPS will restart automatically when utility power returns.
<b>ALL LEDs ARE OFF AND THE UPS IS PLUGGED INTO A WALL OUTLET</b>	
The UPS is shut down and the battery is discharged from an extended outage.	None. The UPS will return to normal operation when the power is restored and the battery has a sufficient charge.
<b>BYPASS AND OVERLOAD LEDs ILLUMINATE, UPS EMITS A SUSTAINED ALARM TONE</b>	
The UPS is overloaded	The connected equipment exceeds the specified "maximum load" as defined in <i>Specifications</i> on the APC by Schneider Electric web site, <a href="http://www.apc.com">www.apc.com</a> .  The alarm remains on until the overload is removed. Disconnect nonessential equipment from the UPS to eliminate the overload condition.

PROBLEM AND POSSIBLE CAUSE	SOLUTION
<b><i>BYPASS LED ILLUMINATES</i></b>	
The bypass switch has been turned on manually or through an accessory.	If bypass is the chosen mode of operation, ignore the illuminated LED. If bypass is not the chosen mode of operation move the bypass switch on the back of the UPS, to the <i>normal</i> position.
<b><i>FAULT AND OVERLOAD LEDs ILLUMINATE, UPS EMITS A SUSTAINED ALARM TONE</i></b>	
The UPS has ceased sending power to connected equipment.	The connected equipment exceeds the specified “maximum load” as defined in <i>Specifications</i> on the APC by Schneider Electric web site, <a href="http://www.apc.com">www.apc.com</a> . Disconnect nonessential equipment from the UPS to eliminate the overload condition. Press the OFF button, then the ON button to restore power to connected equipment.
<b><i>FAULT LED ILLUMINATES</i></b>	
Internal UPS fault.	Do not attempt to use the UPS. Turn the UPS off and have it serviced immediately.
<b><i>REPLACE BATTERY LED ILLUMINATES</i></b>	
Replace Battery LED flashes and short beep is emitted every two seconds to indicate the battery is disconnected.  Weak battery.  Failure of a battery self-test.	Check that the battery connectors are fully engaged.  Allow the battery to recharge for 24 hours. Then, perform a self-test. If the problem persists after recharging, replace the battery.  The UPS emits short beeps for one minute and the <i>Replace Battery</i> LED illuminates. The UPS repeats the alarm every five hours. Perform the self-test procedure after the battery has charged for 24 hours to confirm the <i>Replace Battery</i> condition. The alarm stops and the LED clears if the battery passes the self-test.
<b><i>UPS OPERATES ON BATTERY ALTHOUGH NORMAL LINE VOLTAGE EXISTS</i></b>	
Very high, low, or distorted line voltage. Inexpensive fuel powered generators can distort the voltage.	Move the UPS to a different outlet on a different circuit. Test the input voltage with the utility voltage display.
<b><i>DIAGNOSTIC UTILITY VOLTAGE</i></b>	
All five LEDs are illuminated	The line voltage is extremely high and should be checked by an electrician.
There is no LED illumination	If the UPS is plugged into a properly functioning utility power outlet, the line voltage is extremely low.
<b><i>ONLINE LED</i></b>	
There is no LED illumination	The UPS is running on battery, or it is not turned on.
The LED is blinking	The UPS is running an internal self-test.

## Service

If the unit requires service, do not return it to the dealer. Follow these steps:

- 1 . Review the *Troubleshooting* section of the manual to eliminate common problems.
- 2 . If the problem persists, contact APC by Schneider Electric Customer Support through the APC by Schneider Electric web site, **www.apc.com**.
  - a. Note the model number and serial number and the date of purchase. The model and serial numbers are located on the rear panel of the unit and are available through the LCD display on select models.
  - b. Call Customer Support and a technician will attempt to solve the problem over the phone. If this is not possible, the technician will issue a Returned Material Authorization Number (RMA#).
  - c. If the unit is under warranty, the repairs are free.
  - d. Service procedures and returns may vary internationally. Refer to the APC by Schneider Electric web site, **www.apc.com** for country specific instructions.
- 3 . Pack the unit properly to avoid damage in transit. Never use foam beads for packaging. Damage sustained in transit is not covered under warranty.
  - a. **Note: When shipping within the United States, or to the United States always DISCONNECT ONE UPS BATTERY before shipping in compliance with U.S. Department of Transportation (DOT) and IATA regulations.** The internal batteries may remain in the UPS.
  - b. Batteries may remain connected in the XBP during shipment. Not all units utilize XLBPs.
- 4 . Write the RMA# provided by Customer Support on the outside of the package.
- 5 . Return the unit by insured, prepaid carrier to the address provided by Customer Support.

## **Limited Factory Warranty**

Schneider Electric IT Corporation (SEIT) warrants its products to be free from defects in materials and workmanship for a period of two (2) years from the date of purchase. The SEIT obligation under this warranty is limited to repairing or replacing, at its own sole option, any such defective products. Repair or replacement of a defective product or parts thereof does not extend the original warranty period.

This warranty applies only to the original purchaser who must have properly registered the product within 10 days of purchase. Products may be registered online at [warranty.apc.com](http://warranty.apc.com).

SEIT shall not be liable under the warranty if its testing and examination disclose that the alleged defect in the product does not exist or was caused by end user or any third person misuse, negligence, improper installation, testing, operation or use of the product contrary to SEIT recommendations or specifications. Further, SEIT shall not be liable for defects resulting from: 1) unauthorized attempts to repair or modify the product, 2) incorrect or inadequate electrical voltage or connection, 3) inappropriate on site operation conditions, 4) Acts of God, 5) exposure to the elements, or 6) theft. In no event shall SEIT have any liability under this warranty for any product where the serial number has been altered, defaced, or removed.

**EXCEPT AS SET FORTH ABOVE, THERE ARE NO WARRANTIES, EXPRESS OR IMPLIED, BY OPERATION OF LAW OR OTHERWISE, APPLICABLE TO PRODUCTS SOLD, SERVICED OR FURNISHED UNDER THIS AGREEMENT OR IN CONNECTION HEREWITH.**

**SEIT DISCLAIMS ALL IMPLIED WARRANTIES OF MERCHANTABILITY, SATISFACTION AND FITNESS FOR A PARTICULAR PURPOSE.**

**SEIT EXPRESS WARRANTIES WILL NOT BE ENLARGED, DIMINISHED, OR AFFECTED BY AND NO OBLIGATION OR LIABILITY WILL ARISE OUT OF, SEIT RENDERING OF TECHNICAL OR OTHER ADVICE OR SERVICE IN CONNECTION WITH THE PRODUCTS.**

**THE FOREGOING WARRANTIES AND REMEDIES ARE EXCLUSIVE AND IN LIEU OF ALL OTHER WARRANTIES AND REMEDIES. THE WARRANTIES SET FORTH ABOVE CONSTITUTE SEIT SOLE LIABILITY AND PURCHASER EXCLUSIVE REMEDY FOR ANY BREACH OF SUCH WARRANTIES. SEIT WARRANTIES EXTEND ONLY TO ORIGINAL PURCHASER AND ARE NOT EXTENDED TO ANY THIRD PARTIES.**

**IN NO EVENT SHALL SEIT, ITS OFFICERS, DIRECTORS, AFFILIATES OR EMPLOYEES BE LIABLE FOR ANY FORM OF INDIRECT, SPECIAL, CONSEQUENTIAL OR PUNITIVE DAMAGES, ARISING OUT OF THE USE, SERVICE OR INSTALLATION OF THE PRODUCTS, WHETHER SUCH DAMAGES ARISE IN CONTRACT OR TORT, IRRESPECTIVE OF FAULT, NEGLIGENCE OR STRICT LIABILITY OR WHETHER SEIT HAS BEEN ADVISED IN ADVANCE OF THE POSSIBILITY OF SUCH DAMAGES. SPECIFICALLY, SEIT IS NOT LIABLE FOR ANY COSTS, SUCH AS LOST PROFITS OR REVENUE, WHETHER DIRECT OR INDIRECT, LOSS OF EQUIPMENT, LOSS OF USE OF EQUIPMENT, LOSS OF SOFTWARE, LOSS OF DATA, COSTS OF SUBSTITUANTS, CLAIMS BY THIRD PARTIES, OR OTHERWISE.**

**NOTHING IN THIS LIMITED WARRANTY SHALL SEEK TO EXCLUDE OR LIMIT SEIT LIABILITY FOR DEATH OR PERSONAL INJURY RESULTING FROM ITS NEGLIGENCE OR ITS FRAUDULENT MISREPRESENTATION OF TO THE EXTENT THAT IT CANNOT BE EXCLUDED OR LIMITED BY APPLICABLE LAW.**

To obtain service under warranty you must obtain a Returned Material Authorization (RMA) number from customer support. Customers with warranty claims issues may access the SEIT worldwide customer support network through the APC by Schneider Electric web site: [www.apc.com](http://www.apc.com). Select your country from the country selection drop down menu. Open the Support tab at the top of the web page to obtain information for customer support in your region. Products must be returned with transportation charges prepaid and must be accompanied by a brief description of the problem encountered and proof of date and place of purchase.



# APC by Schneider Electric Worldwide Customer Support

Customer support for this or any other APC by Schneider Electric product is available at no charge in any of the following ways:

- Visit the APC by Schneider Electric web site, [www.apc.com](http://www.apc.com) to access documents in the APC Knowledge Base and to submit customer support requests.
  - **www.apc.com** (Corporate Headquarters)  
Connect to localized APC by Schneider Electric web site for specific countries, each of which provides customer support information.
  - **www.apc.com/support/**  
Global support searching APC Knowledge Base and using e-support.
- Contact the APC by Schneider Electric Customer Support Center by telephone or e-mail.
  - Local, country specific centers: go to **www.apc.com/support/contact** for contact information.
  - For information on how to obtain local customer support, contact the APC by Schneider Electric representative or other distributor from whom you purchased your APC by Schneider Electric product.

© 2014 APC by Schneider Electric. Smart-UPS and PowerChute are owned by Schneider Electric Industries S.A.S. or their affiliated companies. All other trademarks are property of their respective owners.

# APC by Schneider Electric Worldwide Customer Support

Customer support for this or any other APC by Schneider Electric product is available at no charge in any of the following ways:

- Visit the APC by Schneider Electric web site, [www.apc.com](http://www.apc.com) to access documents in the APC Knowledge Base and to submit customer support requests.
  - **www.apc.com** (Corporate Headquarters)  
Connect to localized APC by Schneider Electric web site for specific countries, each of which provides customer support information.
  - **www.apc.com/support/**  
Global support searching APC Knowledge Base and using e-support.
- Contact the APC by Schneider Electric Customer Support Center by telephone or e-mail.
  - Local, country specific centers: go to **www.apc.com/support/contact** for contact information.
  - For information on how to obtain local customer support, contact the APC by Schneider Electric representative or other distributor from whom you purchased your APC by Schneider Electric product.

Elite Partner's authorized by Schneider Electric  
**Powercom Group Co., Ltd.**  
No.10, Street 420, Sangkat Boeung Trabek,  
Khan Chamkarmon, Phnom Penh, Cambodia.  
Tel: +855-23 990 630 / 23 990 631.  
E-mail: [info@powercom-group.com](mailto:info@powercom-group.com)  
<https://www.powercom-group.com>

© 2014 APC by Schneider Electric. Smart-UPS and PowerChute are owned by Schneider Electric Industries S.A.S. or their affiliated companies. All other trademarks are property of their respective owners.

**EN 990-2690C**

**07/2014**